



JULIANA

108_S_2
Assembly Instructions

Assembly Steps





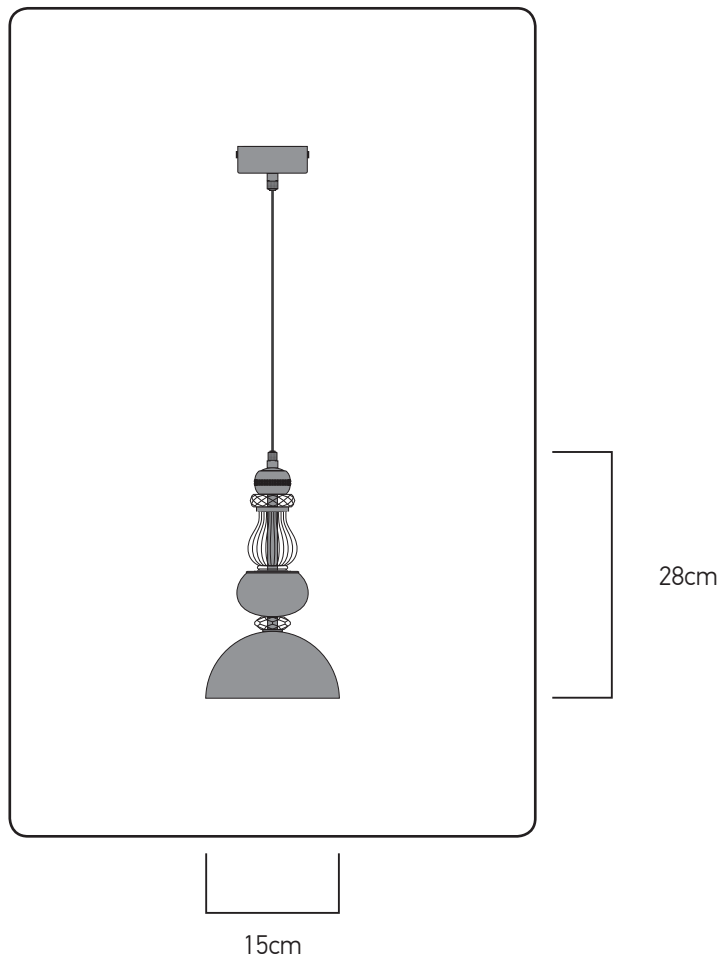

S 2

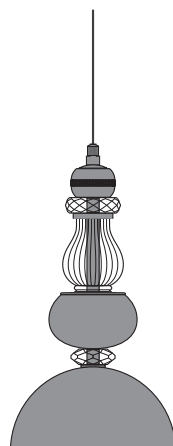

JULIANA_S2

parts_components



reference	lamps	lamp Watt Max	A.C
108/S 2	1 x G9	33 Watt	230V - 50Hz
  	ΗΜΕΡΟΜΗΝΙΑ ΕΛΕΓΧΟΥ TESTING DATE / /	ΥΠΟΓΡΑΦΗ ΕΛΕΓΚΤΗ TEST OPERATOR



DO NOT ASSEMBLE ANY GLASS PARTS THAT PRESENT CRACKS OR ANY OTHER DAMAGED CAUSED BY CARRIAGE OR WRONG PLACEMENT. A CAREFUL CHECK IS SUGGESTED. CLEAN WITH SOFT CLOTH OR MILD RISING AGENT WITH LOW TEMPERATURE WATER.
ΜΗ ΣΥΝΑΡΜΟΛΟΓΕΙΤΕ ΓΥΑΛΙΝΑ ΜΕΡΗ ΠΟΥ ΦΕΡΟΥΝ ΡΩΓΜΕΣ Ή ΑΛΛΕΣ ΖΗΜΙΕΣ ΑΠΟ ΜΕΤΑΦΟΡΑ Ή ΛΑΘΟΣ ΤΟΠΟΘΕΤΗΣΗ. ΚΑΘΑΡΙΣΤΕ ΜΕ ΜΑΛΛΑΚΟ ΠΑΝΙ Ή ΜΕ ΗΠΙΟ ΚΑΘΑΡΙΣΤΙΚΟ ΜΕ ΝΕΡΟ ΣΕ ΧΑΜΗΛΗ ΘΕΡΜΟΚΡΑΣΙΑ.

THIS DESIGN IS PROPERTY OF GRANDO LUCE AND IT IS FORBIDDEN TO COPY ANY PART OF THE DESIGN
ΑΥΤΟ ΤΟ ΣΧΕΔΙΟ ΕΙΝΑΙ ΙΔΙΟΚΤΗΣΙΑ ΤΗΣ GRANDO LUCE ΚΑΙ ΑΠΑΓΟΡΕΥΕΤΑΙ ΑΥΣΤΗΡΩΣ Η ΑΝΤΙΓΡΑΦΗ ΟΛΟΥ Ή ΜΕΡΟΥΣ ΑΥΤΟΥ

STEP_1

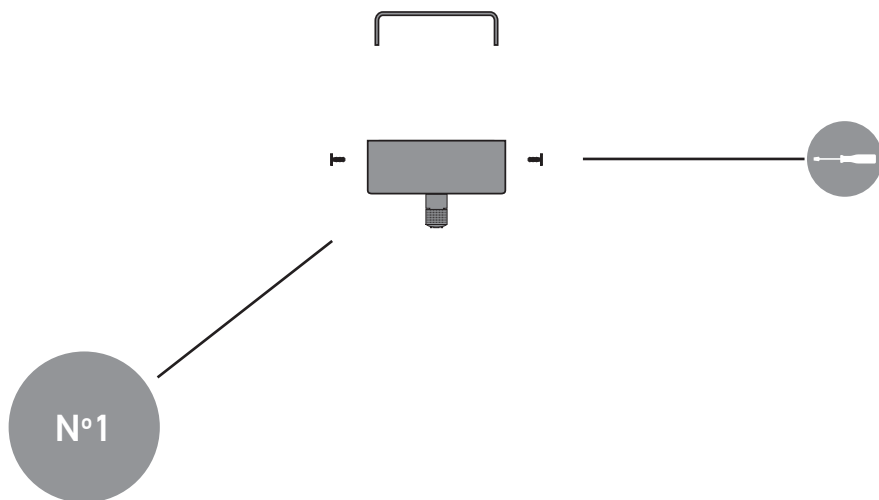

WARNING: fix the marked screws in the safety locking

STEP_2

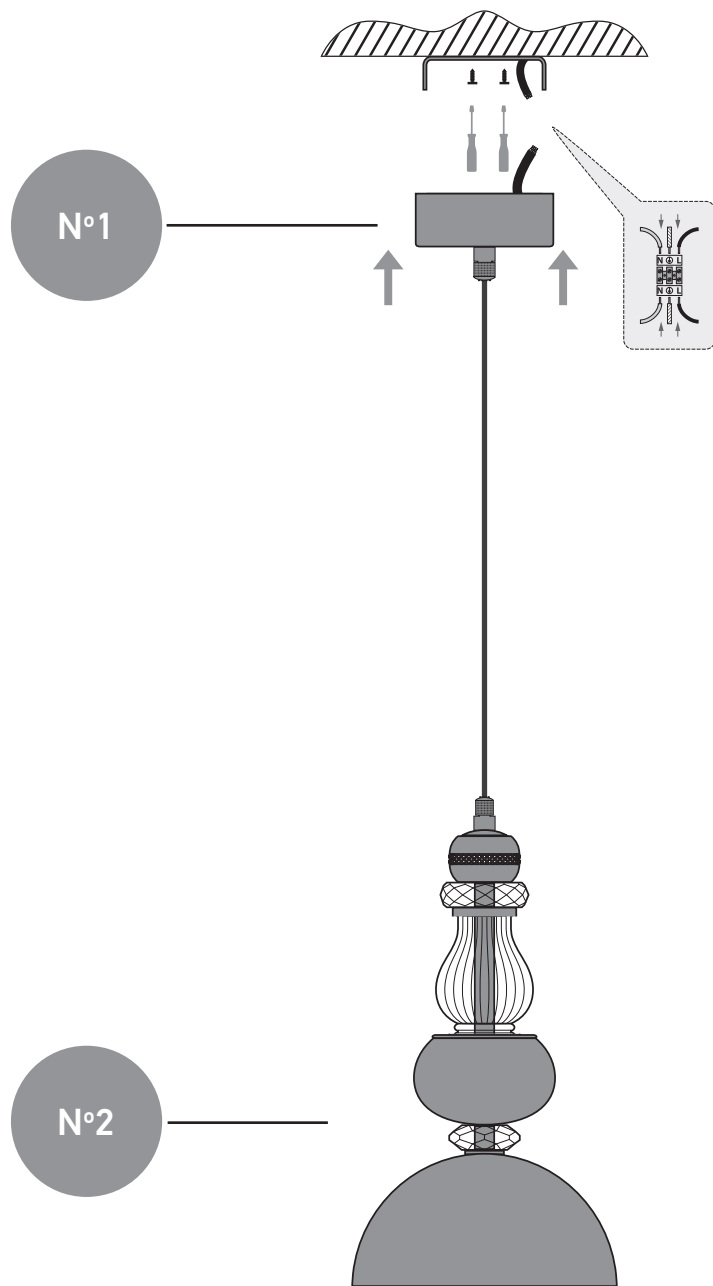

WARNING: fix the marked screws in the safety locking

STEP_3

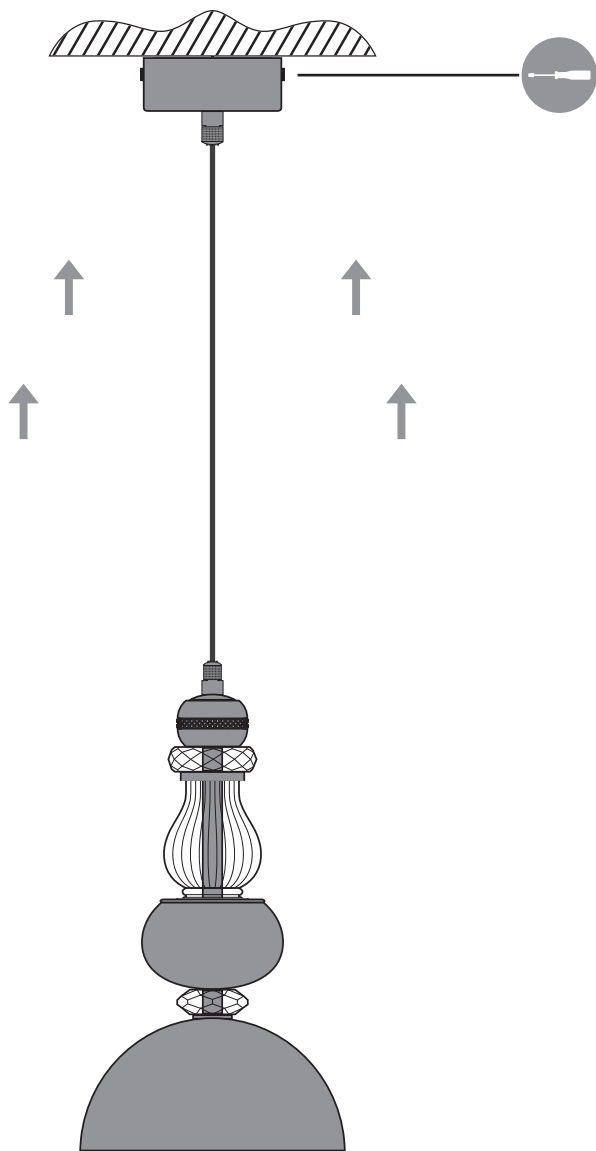

WARNING: fix the marked screws in the safety locking

DECORATION TRIMMINGS VIEW

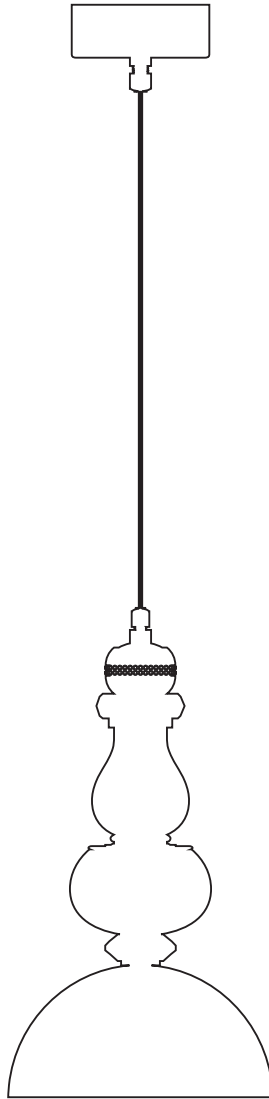



**MADE IN
GREECE**

11 Karditsis str, 42100
T +30 2431 0 76646
info@grandoluce.com

Trikala, Greece
F +30 2431 0 76696
www.grandoluce.com